

# SG 4710

---

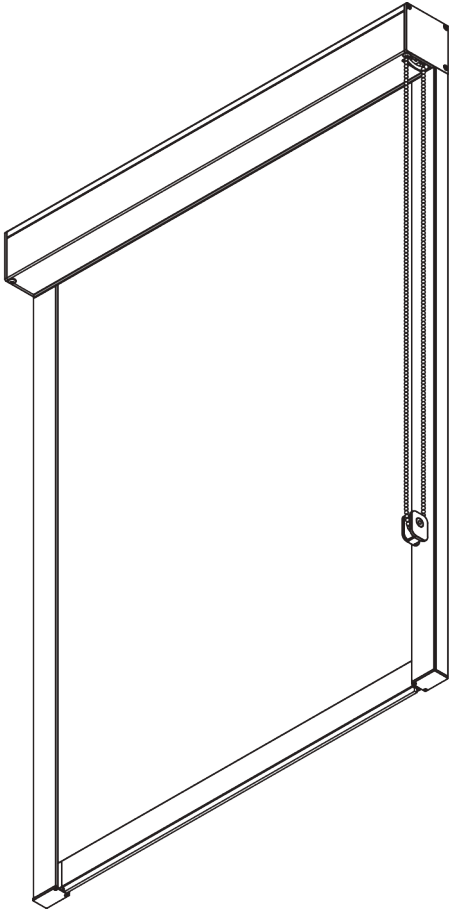
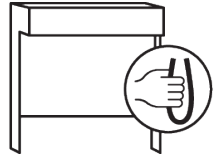

## PRODUCT INFORMATION

- **Operation:** chain
- **Range:** S
- **Fitting:** ceiling, wall, recess
- **Colours:** white RAL 9016 or black RAL 9005, special colours possible
- **Fabrics:** refer to Silent Gliss fabric collection

### **Features:**

- Zip technology
- Stainless steel bead chain
- 2-to-1 gear drive
- 40 mm side channel, pre-drilled fixing points

# SYSTEM SPECIFICATIONS

## A. SYSTEM DIMENSIONS

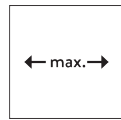

1.6 m

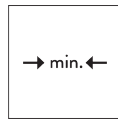

65 cm

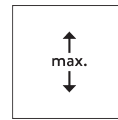

1.6 m



2.5 m<sup>2</sup>



2 kg

## B. PROFILE

### Profile information

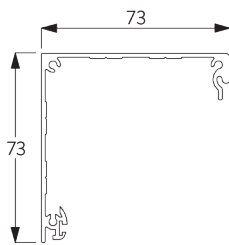

**SG 10994**  
Box case 73 mm

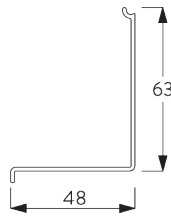

**SG 10995**  
Box cover 73 mm

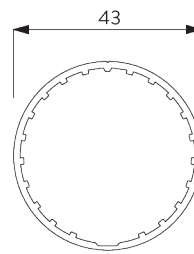

**SG 10532**  
Tube ø 43 mm

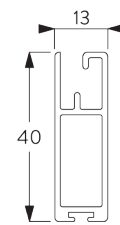

**SG 10993**  
Bottom bar

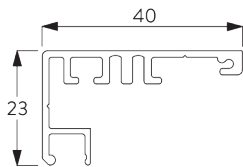

**SG 11418**  
Side guide case

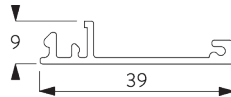

**SG 11419**  
Side guide cover

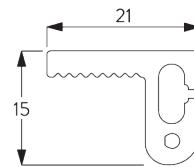

**SG 11421**  
Zip profile

## C. HOW TO MEASURE

### Inside fitting

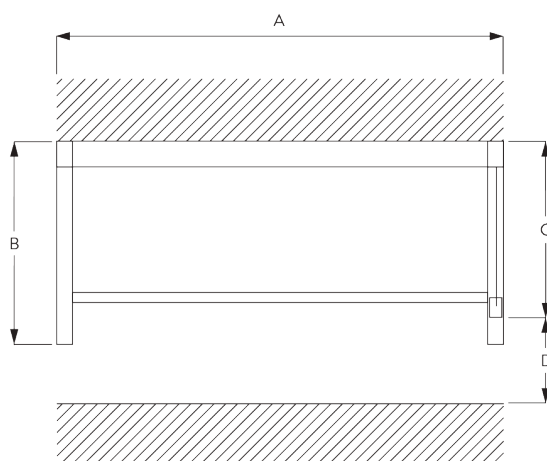

- A: System width
- B: System height
- C: Chain height
- D: Safety Retainer SG 10731 min. 150 cm above floor

## Face fitting

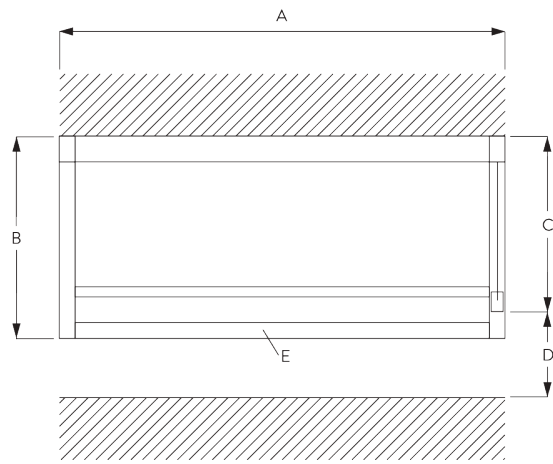

- A: System width
- B: System height
- C: Chain height
- D: Safety Retainer SG 10731 min. 150 cm above floor
- E: Optional: end profile (SG 11418 / SG 11419)

## D. SPECIFICATION

### TEXT

#### **EN**

Silent Gliss SG 4710 Chain Operated Dim-Out Roller Blind System. For blinds up to 1.6 m wide by 1.6 m drop, max 2.5sq m. Supplied complete and made to measure comprising aluminium headbox SG 10994-5 (73 mm), side profiles SG 11418 / SG 11419 and bottom hem bar SG 10993 in white or black powder coat finish as standard. Fabric edges retained by two component zip profile SG 11421. Operation by stainless steel bead chain with chain retainer SG 10731. Compliant to Child Safety Legislation EN 13120.

#### **SV**

Silent Gliss SG 4710 mörkläggningsrullgardin med kulekedja. För system max 1,6 x 1,6 m, eller totalt max 2,5 m<sup>2</sup>. Levereras komplett i kundmått bestående av toppkassett i aluminium SG 10994-5 (73 mm), sidoprofiler SG 11418 / SG 11419 samt tyngdprofil SG 10993 i vit eller svart epoxy lack. Textilens kant försedd med zip profil SG 11421. Manövrering med rostfri kulekedja av stål samt väggfäste SG 10731. Textil från Silent Gliss textilprogram i prisgrupp 1-3.

#### **NO**

Silent Gliss SG 4710 Mørkleggende rullegardin med kulekedje. For system inntil 1,6 x 1,6 m, eller totalt max 2,5 m<sup>2</sup>. Levereras komplett måltilpasset. Består av toppkasse i aluminium SG 10994-5 (73 mm), sideprofiler SG 11418 / SG 11419 samt tyngdeprofil SG 10993 i hvit eller svart epoxy lakk. Sidene på tekstile er festet med zip profil SG 11421. Betjening med rustrikket kulekedje samt veggfeste SG 10731. Tekstiler fra Silent Gliss tekstilkolleksjon i prisgrupp 1-3.

# FITTING

## A. FITTING INFORMATION

For detailed fitting information, visit the Silent Gliss website.

**Inside fitting - fixing points**

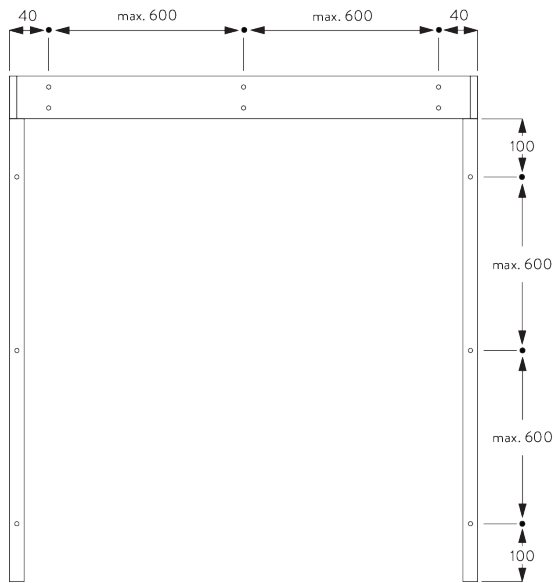

**Face fitting - fixing points**

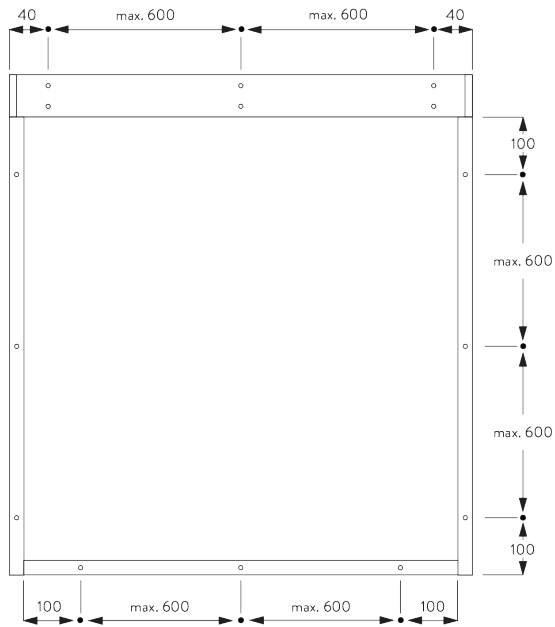

**B. CEILING FITTING**

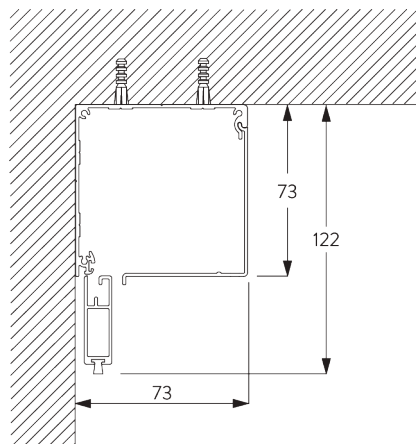

### C. WALL FITTING

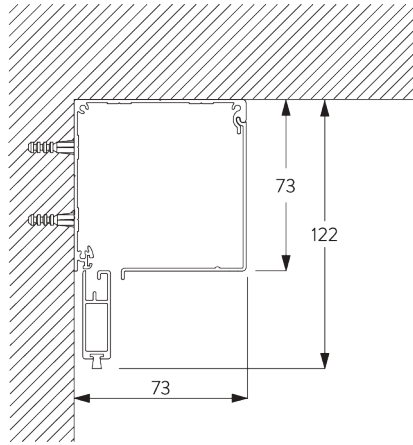

### D. RECESS FITTING

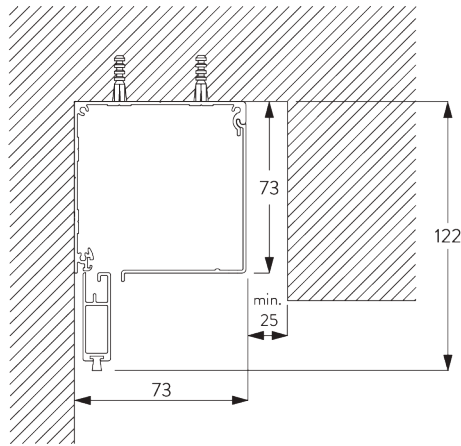

### E. SIDE PROFILES SG 11418 / SG 11419

Inside fitting

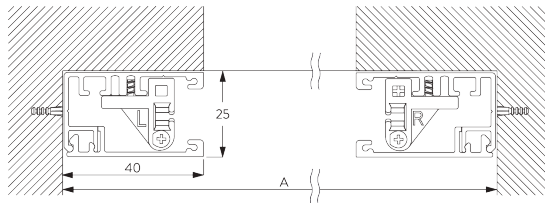

A: System width



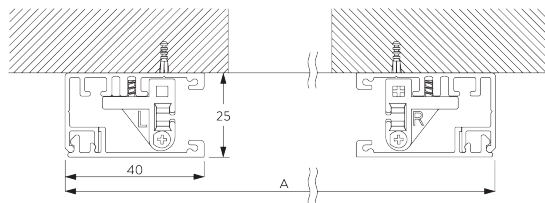







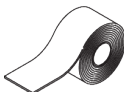

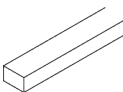
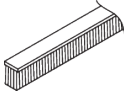

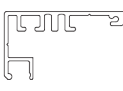
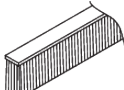

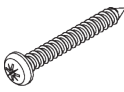
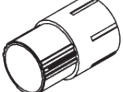
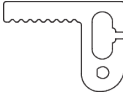
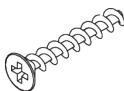
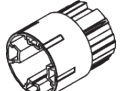
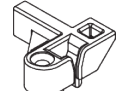
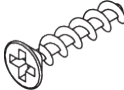
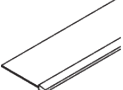
Face fitting

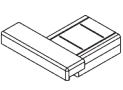
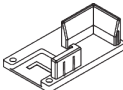
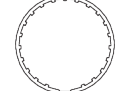
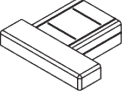
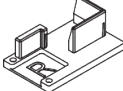
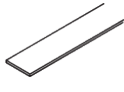
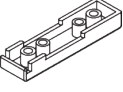

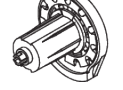
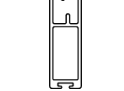
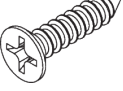
A: System width

# PARTS

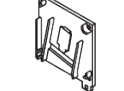
## A. STANDARD PARTS

	<b>SG 4226</b> Double tape 30 mm		<b>SG 11005</b> End cover right 73 mm		<b>SG 11060</b> Foam tape adhesive
	<b>SG 4508</b> Brush 5x7 mm		<b>SG 11010</b> Clip		<b>SG 11418</b> Side guide case
	<b>SG 4509</b> Brush 5x12 mm		<b>SG 11011</b> Clip		<b>SG 11419</b> Side guide cover
	<b>SG 6791</b> Pan head screw 3.9x32		<b>SG 11014</b> Tube adapter		<b>SG 11421</b> Zip profile
	<b>SG 6933</b> PT Countersunk screw KA25x16		<b>SG 11015</b> Tube adapter		<b>SG 11473</b> Zip guide left
	<b>SG 6936</b> PT Countersunk screw KA22x10		<b>SG 11025</b> Zip		<b>SG 11474</b> Zip guide right
	<b>SG 6942</b> Pan head screw KA30x8		<b>SG 11028</b> End cover left		<b>SG 11475</b> Side guide end cover left
	<b>SG 10532</b> Tube ø 43 mm		<b>SG 11029</b> End cover right		<b>SG 11476</b> Side guide end cover right
	<b>SG 10668</b> PVC strip 10 mm		<b>SG 11030</b> Cover		
	<b>SG 10731</b> Child safety retainer set		<b>SG 11031</b> Chain drive		
	<b>SG 10993</b> Bottom bar		<b>SG 11034</b> Countersunk head screw 3.5x16		
	<b>SG 10994</b> Box case 73 mm		<b>SG 11035</b> Countersunk head screw 2.2x9.5		
	<b>SG 10995</b> Box cover 73 mm		<b>SG 11040</b> Bead chain ø 4.5 mm		
	<b>SG 11004</b> End cover left 73 mm		<b>SG 11059</b> Pan head screw with flange M4x12		

## **B. OPTIONAL PARTS**

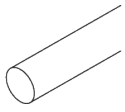

**SG 4951**

*Bottom weight ø 8 mm*

