

SG 6870

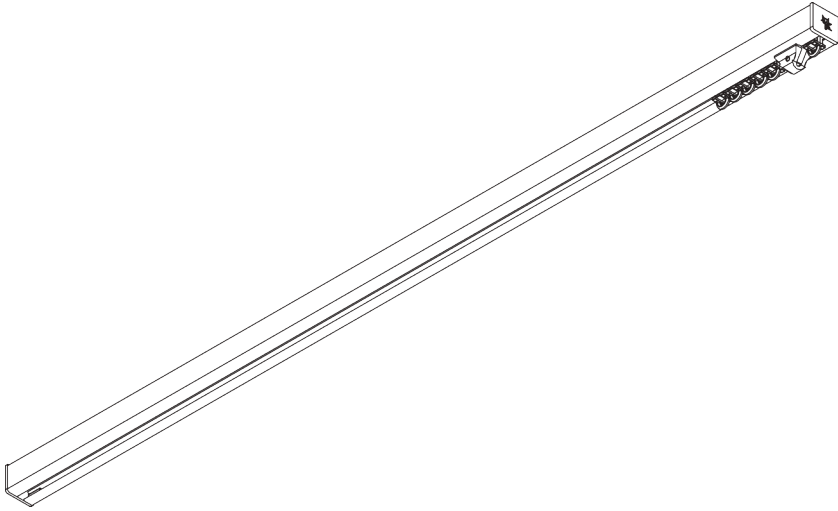
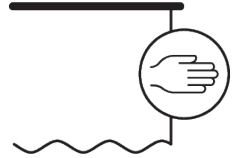

PRODUCT INFORMATION

- **Operation:** hand
- **Range:** M - L
- **Fitting:** ceiling, wall, recess
- **Colours:** white RAL 9016, black RAL 9005 or anodised aluminum, special colours possible (recess profile only in white RAL 9016, black RAL 9005 or special color)
- **Fabrics:** refer to Silent Gliss fabric collection

Features:

- 2-component (2C) glider technology
- Wave (2C)
- Bendable
- Bendable recess profile

SYSTEM SPECIFICATIONS

A. PROFILE

Profile and bending information

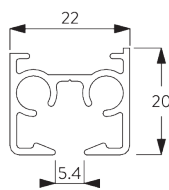

SG 11190

Profile

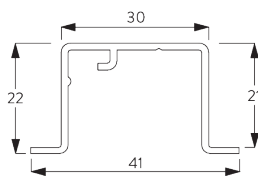

SG 11230

Recess profile



B. HOW TO MEASURE

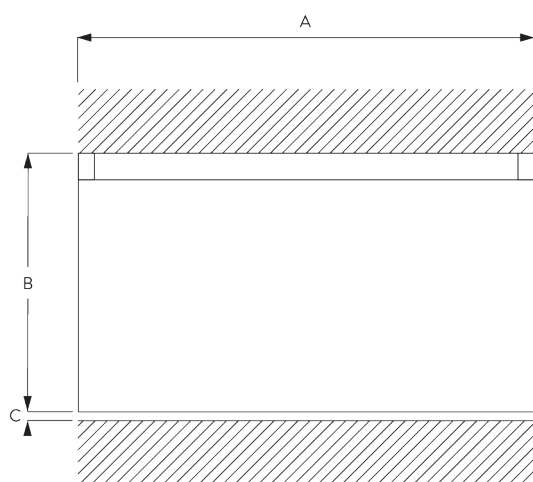

A: System width

B: System height

C: Distance between floor and fabric

C. SPECIFICATION TEXT

EN

Silent Gliss SG 6870 Hand Drawn Curtain Track System. Comprises aluminium profile SG 11190 supplied made to measure in silver anodised or white powder coated, alternatively a specified RAL colour. SG 11130 at 14/m, 2 end covers SG 11233 and 2 SG 6065 stops. Top fixed with brackets SG 3825/3826/3832 max. 500 mm centres. Wall fix SG Smart Fix at max. 500mm centres. Silent Gliss Wave option is available. Optional recess profile SG 11230.

SV

Silent Gliss SG 6870 handdragssystem. Består av aluminiumprofil SG 11190 i specificerad längd i vitlack, alu natur eller angiven RAL färg. Kan användas med system Wave. 14 st SG 11300 SILENT TRACK glid per meter, 2 st SG 11233 ändskydd samt 2 st SG 6065 vridstopp per system. Takmonteras med fäste SG 3825/3826/3832 c/c 500 mm. Vägghäring med SG Smart Fix c/c 500 mm. Kan kombineras med Wave. Kan levereras med infällningsprofil SG 11230.

NO

Silent Gliss SG 6870 Manuell gardinskinne. Består av aluminiumprofil SG 11190 i spesifisert lengde, standard i hvitlakkert eller alu natur. Kan også leveres i spesifisert RAL farge. 14 stk SG 11300 SILENT TRACK glidere pr meter, 2 stk 11233 endeløkk og 2 stk SG 6065 vrilstopp pr system. Takmonteres med feste SG 3825/3826/3832 c/c 500mm. Veggmontering med SG Smart Fix c/c 500 mm. Kan kombineres med Wave system. Kan leveres med profil for innfelling SG 11230.

DA

Silent Gliss SG 6870 håndtrukket gardinskinnesystem. Består af en aluminiumprofil SG 11190 i ønsket længde, sølvanodiseret eller hvid pulverlakering, alternativt en specificeret RAL-farve. 14 stk. SG 11300 glidere pr. m og 2 stk. SG 11233 endelæg samt 2 stk. SG 6065 endestop. Loftmonteres med beslagene SG 3825/3826/3832 med højst 500 mm afstand. Vægmonteres med SG Smart Fix med en afstand på højst 500 mm. Kan bruges med Silent Gliss Wave. Kan leveres med indfældningsprofil SG 11230.

FITTING

A. FITTING INFORMATION

For detailed fitting information, visit the Silent Gliss website.

Fixing points

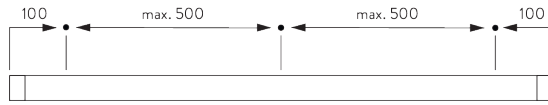

B. CEILING FITTING

Clamp SG 3825

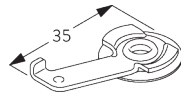
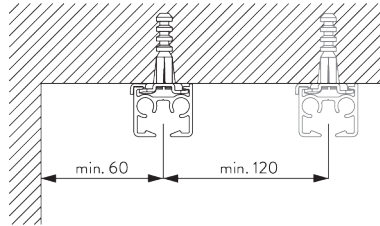

SG 3825
Clamp

Bracket SG 3826

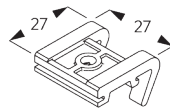
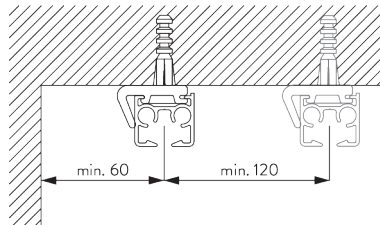

SG 3826
Bracket

Bracket SG 3832

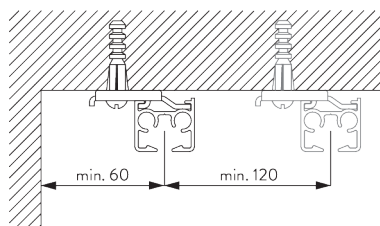

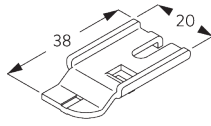

SG 3832

Bracket

C. WALL FITTING

Smart Fix

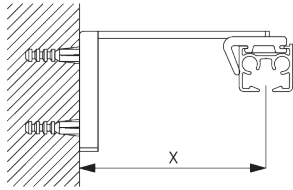

Smart Fix SG 11200 - SG 11205 and bracket SG 3826:

Screw SG 10492 (M4x8) needed.

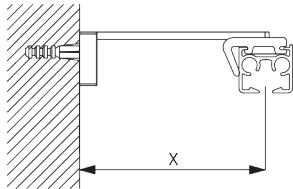

Square Smart Fix SG 11210 - SG 11215 and bracket SG 3826:

Screw SG 10492 (M4x8) needed.

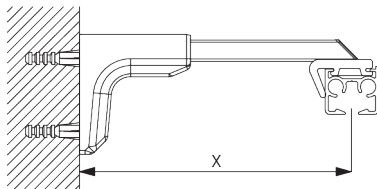

Universal Smart Fix SG 11154 - SG 11156 and bracket SG 3826:

Screw SG 10277 (M4x12) needed.

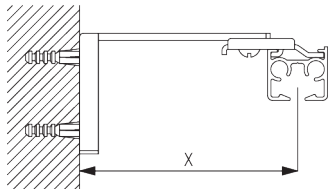

Smart Fix SG 11200 - SG 11205 and bracket SG 3832:

Screw SG 10492 (M4x8) needed.

Smart Fix	X mm (SG 3826 / SG 3825)	X mm (SG 3832)
SG 11200 / SG 11210	52	70
SG 11201 / SG 11211	72	90
SG 11202 / SG 11212	92	110
SG 11203 / SG 11213	112	130
SG 11204 / SG 11214	142	160
SG 11205 / SG 11215	192	210
SG 11154	102-130	120-148
SG 11155	132-160	150-178
SG 11156	182-210	200-228

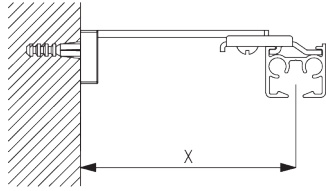

Square Smart Fix SG 11210 - SG 11215 and bracket SG 3832:
Screw SG 10492 (M4x8) needed.

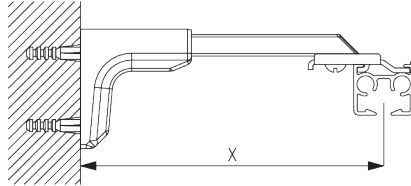

Universal Smart Fix SG 11154 - SG 11156 and bracket SG 3832:
Screw SG 10407 (M4x10) needed.

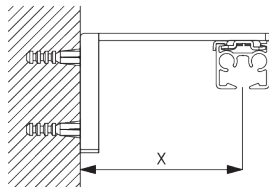

Smart Fix SG 11200 - SG 11205 and clamp SG 3825:
Screw SG 10074 (M4x8) needed.

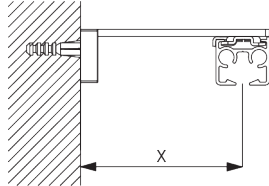

Square Smart Fix SG 11210 - SG 11215 and clamp SG 3825:
Screw SG 10074 (M4x8) needed.

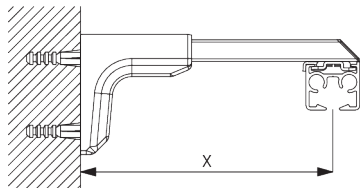

Universal Smart Fix SG 11154 - SG 11156 and bracket SG 3825:
Screw SG 11158 (M4x12) needed.

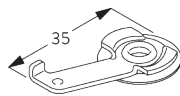

SG 3825
Clamp

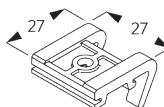

SG 3826
Bracket

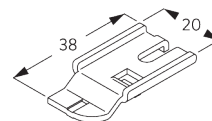

SG 3832
Bracket



SG 10074
Countersunk head screw
M4x8



SG 10277

Pan head screw M4x12



SG 10407

Pan head screw M4x10



SG 10492

Pan head screw M4x8



SG 11158

Countersunk head screw
M4x12

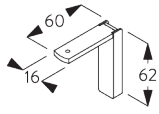

SG 11200

Smart Fix 60 mm

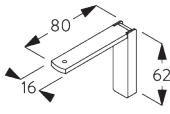

SG 11201

Smart Fix 80 mm

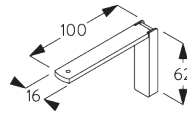

SG 11202

Smart Fix 100 mm

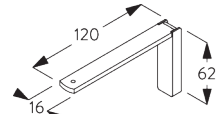

SG 11203

Smart Fix 120 mm

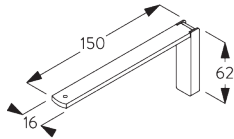

SG 11204

Smart Fix 150 mm

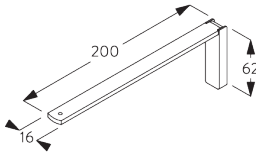

SG 11205

Smart Fix 200 mm

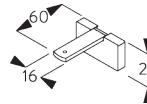

SG 11210

Square Smart Fix 60 mm

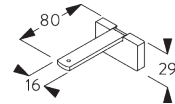

SG 11211

Square Smart Fix 80 mm

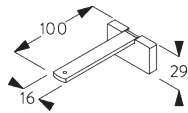

SG 11212

Square Smart Fix 100 mm

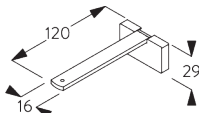

SG 11213

Square Smart Fix 120 mm

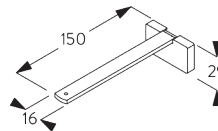

SG 11214

Square Smart Fix 150 mm

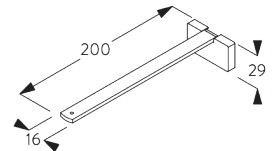

SG 11215

Square Smart Fix 200 mm

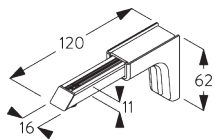

SG 11154

Universal Smart Fix 120 mm

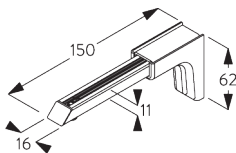

SG 11155

Universal Smart Fix 150 mm

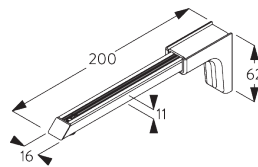

SG 11156

Universal Smart Fix 200 mm

Bracket SG 3836

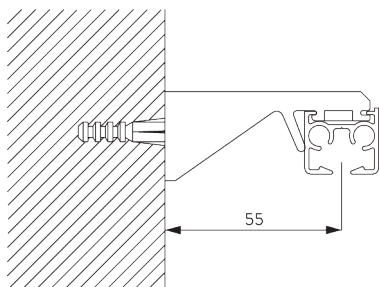

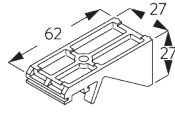

SG 3836
Bracket

D. RECESS FITTING

Recess profile
SG 11230

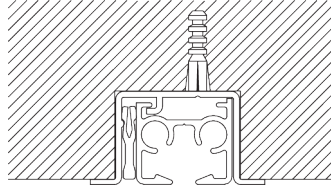

One wedge SG 10157 per fixing point.
For detailed recess fitting, visit the Silent Gliss website.

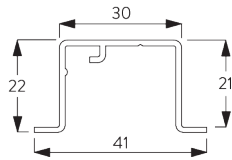

SG 11230
Recess profile

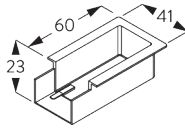

SG 11238
Recess Mask

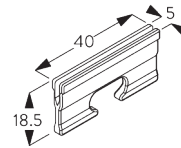

SG 10157
Wedge

SYSTEM OPTIONS

A. WAVE

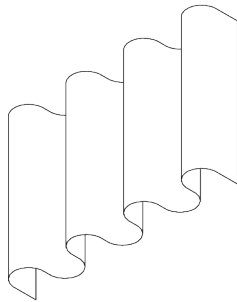

SG 11295

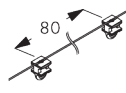

SG 11302

Standard components:

- SG 11295 End stop
- SG 11302 Wave 2C glider cord 80 mm

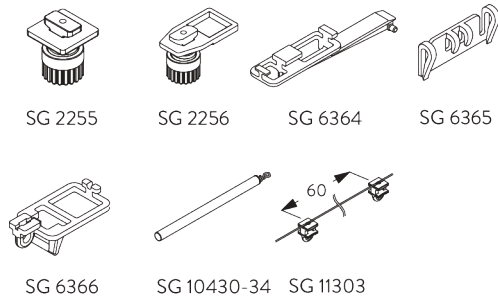

Optional components:

- SG 2255 Brake
- SG 2256 Brake
- SG 6364 Wave extension
- SG 6365 Wave hanger
- SG 6366 Wave carrier for draw rod
- SG 10430-34 Draw rod
- SG 11303 Wave 2C glider cord 60 mm

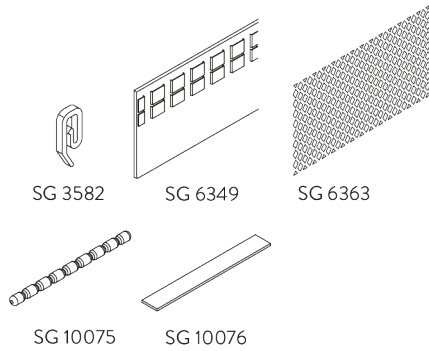

Curtain components:

- SG 3582 Hook
- SG 6349 Wave curtain tape
- SG 6363 Wave top hemming tape
- SG 10075 Lead weight 50 gr/m
- SG 10076 Fabric weight

Wave stack depth - 2C glider cord (standard components)

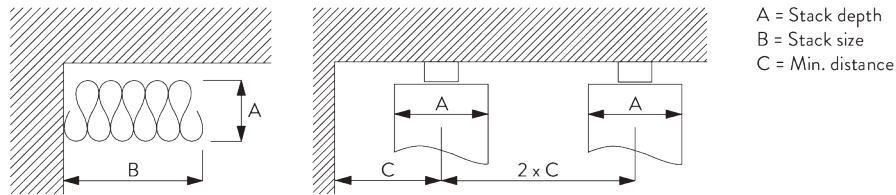





2C Glider cord SG 11302	Pockets between hooks	Approx. curtain fullness	Stack depth A	Stack size B*	Min distance C
80	6	~2.1	140	180 per metre of track	90
80	7	~2.3	160	180 per metre of track	100

2C Glider cord SG 11303	Pockets between hooks	Approx. curtain fullness	Stack depth A	Stack size B*	Min distance C
60	4	~2.1	100	230 per metre of track	70
60	5	~2.3	120	230 per metre of track	80



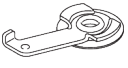

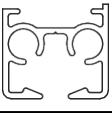

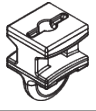



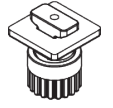

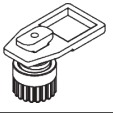



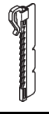
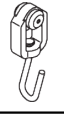

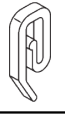
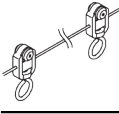
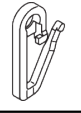

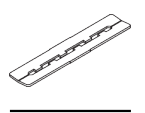

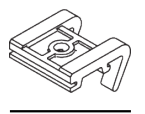
*Stack size B when using optional extension arm increases by 150 mm per curtain stack!

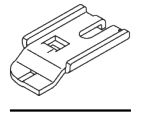
PARTS

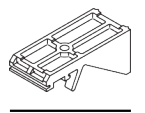
A. STANDARD PARTS

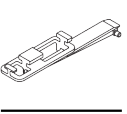
	SG 3599 Hook
	SG 3825 Clamp
	SG 6065 End stop
	SG 6086 Spring stop
	SG 11190 Profile
	SG 11233 End cover
	SG 11300 2C glider

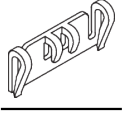
B. OPTIONAL PARTS

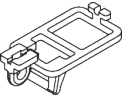
	SG 2255 Brake		SG 6057 Glider
	SG 2256 Brake		SG 6064 End stop
	SG 3012 Hook		SG 6082 Glider
	SG 3555 Hook		SG 6094 Roller
	SG 3581 Hook		SG 6098 Roller
	SG 3582 Hook		SG 6099 Wave roller cord 80 mm
	SG 3598 Eyelet		SG 6146 Hook
	SG 3802 Connection bridge		SG 6240 Roller
	SG 3826 Bracket		SG 6283 Roller
	SG 3832 Bracket		SG 6349 Wave curtain tape
	SG 3836 Bracket		SG 6363 Wave top hemming tape
	SG 6004 Eyelet		SG 6364 Wave extension
	SG 6005 Hook		SG 6365 Wave hanger
	SG 6053 Spring stop		SG 6366 Wave carrier for draw rod

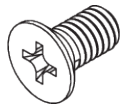
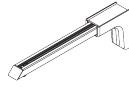
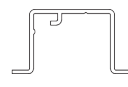
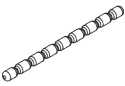
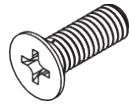
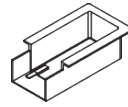
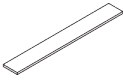
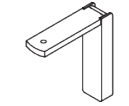
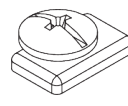
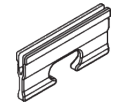
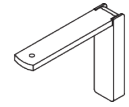
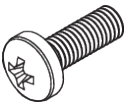
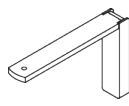
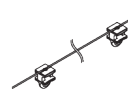
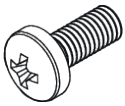
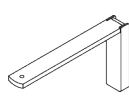
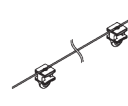
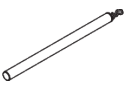
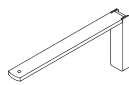
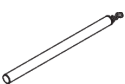
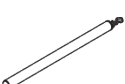
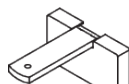
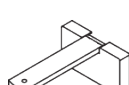
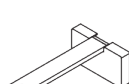
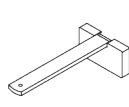
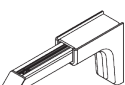
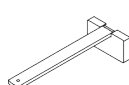
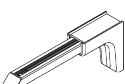
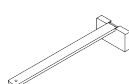
**SG 10074***Countersunk head screw M4x8***SG 11156***Universal Smart Fix 200 mm***SG 11230***Recess profile***SG 10075***Lead weight 50 g/m***SG 11158***Countersunk head screw M4x12***SG 11238***Recess Mask***SG 10076***Fabric weight***SG 11200***Smart Fix 60 mm***SG 11295***End stop***SG 10157***Wedge***SG 11201***Smart Fix 80 mm***SG 11301***2C glider on strip***SG 10277***Pan head screw M4x12***SG 11202***Smart Fix 100 mm***SG 11302***Wave 2C glider cord 80 mm***SG 10407***Pan head screw M4x10***SG 11203***Smart Fix 120 mm***SG 11303***Wave 2C glider cord 60 mm***SG 10430***Draw rod 50 cm***SG 11204***Smart Fix 150 mm***SG 11305***2C glider for direct sewing***SG 10431***Draw rod 75 cm***SG 11205***Smart Fix 200 mm***SG 10432***Draw rod 100 cm***SG 11210***Square Smart Fix 60 mm***SG 10433***Draw rod 125 cm***SG 11211***Square Smart Fix 80 mm***SG 10434***Draw rod 150 cm***SG 11212***Square Smart Fix 100 mm***SG 10492***Pan head screw M4x8***SG 11213***Square Smart Fix 120 mm***SG 11154***Universal Smart Fix 120 mm***SG 11214***Square Smart Fix 150 mm***SG 11155***Universal Smart Fix 150 mm***SG 11215***Square Smart Fix 200 mm*

