

# SG 2730

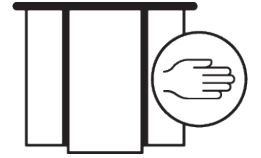

## FLEX

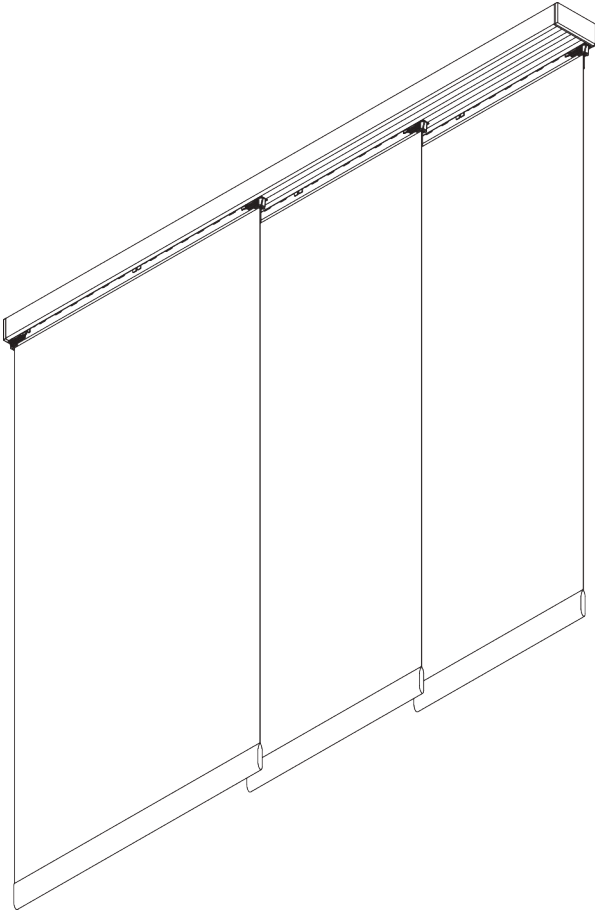

### PRODUCT INFORMATION

- **Operation:** hand
- **Range:** S - L
- **Fitting:** ceiling, wall
- **Colours:** white RAL 9016, anodised aluminum
- **Fabrics:** refer to Silent Gliss fabric collection

#### **Features:**

- 2-component (2C) roller technology
- Silent and smooth running
- Free floating or connectable panels
- Bendable

# SYSTEM SPECIFICATIONS

## A. SYSTEM DIMENSIONS



Panels free floating:  
unlimited  
Panels connected: 6 m

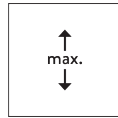

3 m



Max. 2 kg per m

## B. PROFILE

Profile and bending information

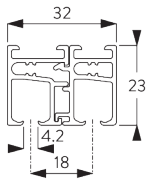

**SG 10132**

Profile 2-channel

Radius:  
✓ 15 cm, >25 cm

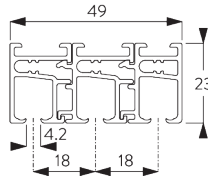

**SG 10133**

Profile 3-channel

Radius:  
✓ 15 cm, >25 cm

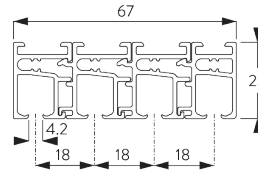

**SG 10134**

Profile 4-channel

Radius:  
✓ 15 cm, >25 cm

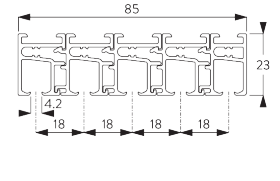

**SG 10135**

Profile 5-channel

Radius:  
✓ 15 cm, >25 cm

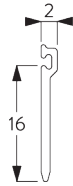

**SG 10179**

Profile



**SG 10180**

Carrier flexible

## C. HOW TO MEASURE

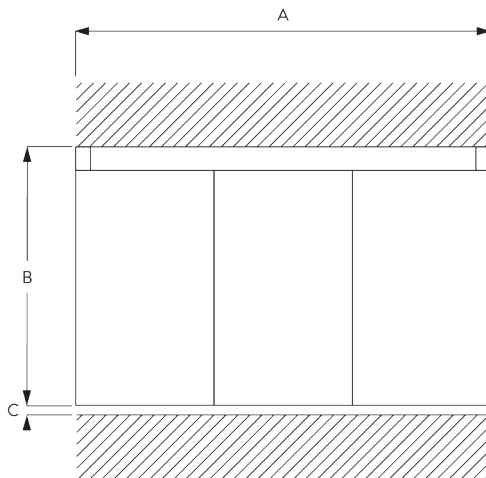

A: System width

B: System height

C: Distance between floor and fabric

## Dimensions of Panels

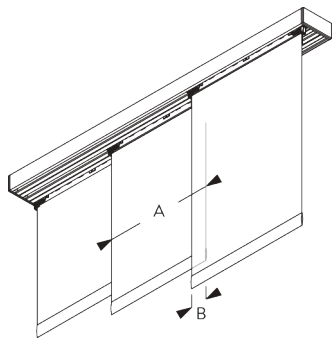

### Free floating:

A: Recommended panel width: 500 - 1200

### Connected:

A: Recommended panel width: 500 - 1200

B: Overlap: min. 120

## D. SPECIFICATION

### TEXT

### EN

*Silent Gliss SG 2730 Flex System. Curved panel glide system supplied made to measure and complete comprising profiles SG 10132 / SG 10133 / SG 10134 / SG 10135 as necessary with carrier SG 10180 with associated components and flexible lead bottom weight SG 10233. Fabric panels stack right hand single / left hand single / pair / centre. Hand operated with panels unconnected / connected using draw rod of suitable height. Ceiling fix direct with suitable screw. Wall fix with SG Smart Fix brackets. Max. distance 800 mm between fixing points. Fabric to be chosen from Silent Gliss fabric collection, Price Group 1 / 2 / 3.*

### SV

*Silent Gliss SG 2730 Flex böjbart skärmgardinsystem. Levereras komplett i specificerat mått innefattande profil 10132 / SG 10133 / SG 10134 / SG 10135 med vagnar SG 10180 med tillhörande komponenter samt tyngdprofil SG 10233. Textilpaneler med sidöppning höger / vänster / mittöppning / centrerad. Manövreras för hand med individuellt flyttbara textiler/kopplade med dragstav anpassad till lämplig höjd. Takmontering med skruv direkt i tak anpassad efter fästmaterial. Vägghävt montering med SG Smart Fix. Max. c/c 800 mellan fästpunkter. Textil från Silent Gliss textilprogram i prisgrupp 1-4.*

### NO

*Silent Gliss SG2700 Flex bøypart panelsystem. Leveres komplett måltilpasset. Består av profil 10132/SG10133/SG10134/SG10135 med vogner SG10180 inkl. tilhørende komponenter samt tyngdeprofil SG10233. Tekstilpaneler med sideåpning høyre/venstre / midtåpning / sentrert. Betjenes for hånd med individuelt bevegelige tekstiler/koblet med betjeningsstav, tilpasset egnet høyde. Takmontering med skruv direkte i tak, tilpasset monteringsmaterial. Veggmontering med SG Smart Fix vinkler. Max c/c 800 mm mellom festepunkt. Tekstil fra Silent Gliss tekstilkolleksjon i prisgruppe 1-4.*

### DA

*Silent Gliss SG 2730 Flex System. Bøjeligt panelsystem, der leveres i ønsket længde og komplet, bestående af profilerne SG 10132 / SG 10133 / SG 10134 / SG 10135 efter behov med vogn SG 10180 med tilhørende komponenter og fleksibel tyngdeprofil SG 10233. Tekstilpaneler med sideåbning højre side enkelt / venstre side enkelt / par / centreret. Betjenes manuelt hvis panelerne ikke er tilsluttede / tilsluttede med en trækstang af passende højde. Fastgøres direkte i loftet med passende skrue. Vægghævet monteres med SG Smart Fix. Afstand mellem fastgøringspunkter højst 800 mm. Stoffet vælges fra Silent Gliss stofprogrammet, prisgruppe 1 / 2 / 3.*

# FITTING

## A. FITTING INFORMATION

### Fixing points

For detailed fitting information, visit the Silent Gliss website.

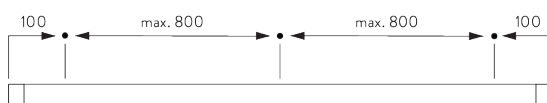

## B. CEILING FITTING

### Direct fitting

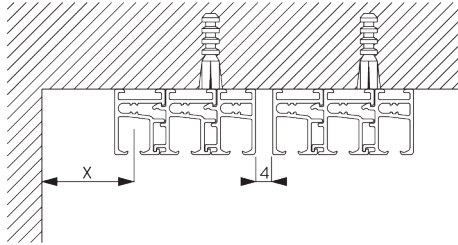

*X = depending on room conditions*

## C. WALL FITTING

### Smart Fix

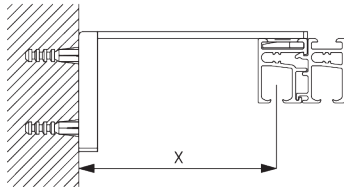

#### Smart Fix with slot SG 11206 - SG 11208:

*Screw SG 10395 (M4x6) needed.*

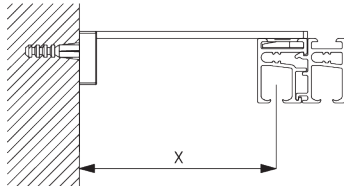

#### Square Smart Fix with slot SG 11216 - SG 11218:

*Screw SG 10395 (M4x6) needed.*

Smart Fix	X mm (SG 10132)	X mm (SG 10133)	X mm (SG 10134)	X mm (SG 10135)
SG 11206 / SG 11216	50	32	-	-
SG 11207 / SG 11217	70	52	34	-
SG 11208 / SG 11218	90	72	44	on request

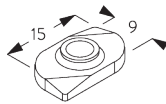

#### SG 10160

Slot nut



#### SG 10395

Pan head screw M4x6

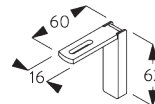

#### SG 11206

Smart Fix with slot 60 mm

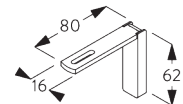

#### SG 11207

Smart Fix with slot 80 mm

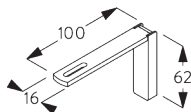

#### SG 11208

Smart Fix with slot 100 mm

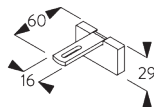

#### SG 11216

Square Smart Fix with slot 60 mm

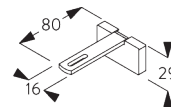

#### SG 11217

Square Smart Fix with slot 80 mm

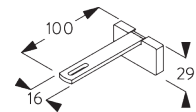

#### SG 11218

Square Smart Fix with slot 100 mm

# SYSTEM OPTIONS

## A. OPERATION

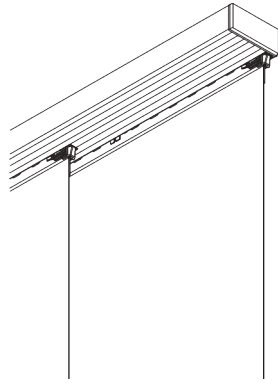

Free floating (unconnected panels)

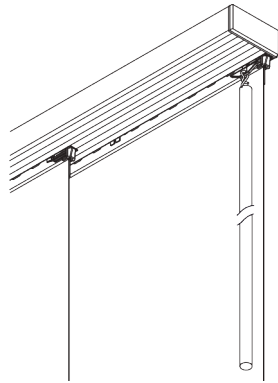

Connected panels (draw rod optional)

## B. PANEL STACKING (CONNECTED)



Single stack  
Note: dot = fixed panel



Pair stack  
Note: dot = fixed panel

Other variations are possible. Same splitting for curved profiles.

# PARTS

## A. STANDARD PARTS

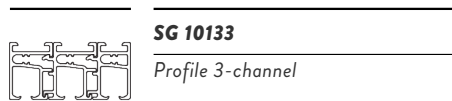

**SG 10133**  
Profile 3-channel



**SG 10159**  
Countersunk head screw 3.5x13



**SG 10163**  
End cover

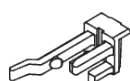

**SG 10167**  
Clip left

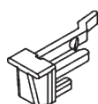

**SG 10168**  
Clip right



**SG 10179**  
Profile



**SG 10180**  
Carrier flexible

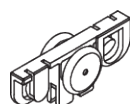

**SG 10200**  
2C roller

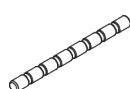

**SG 10233**  
Lead weight 100 gr/m



**SG 10234**  
Fabric weight glass

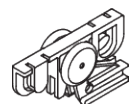

**SG 10237**  
Clip holder



**SG 10248**  
Screw Pozi 4.5x70 mm SPAX

## B. OPTIONAL PARTS

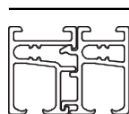

**SG 10132**  
Profile 2-channel



**SG 10134**  
Profile 4-channel



**SG 10135**  
Profile 5-channel

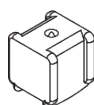

**SG 10156**  
End stop



**SG 10160**  
Slot nut



**SG 10162**  
End cover



**SG 10164**  
End cover



**SG 10165**  
End cover

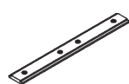

**SG 10177**  
Connection bridge

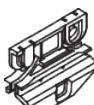

**SG 10196**  
Eyelet for draw rod



**SG 10235**  
Sticker for screw head



**SG 10239**  
Angle left

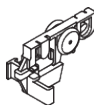

**SG 10241**  
Angle right



**SG 10243**  
Angle



**SG 10244**  
Slider



**SG 10247**  
Screw Pozi 4.5x50 mm SPAX



**SG 10395**  
Pan head screw M4x6



**SG 10430**  
Draw rod 50 cm



**SG 10431**  
Draw rod 75 cm



**SG 10432**  
Draw rod 100 cm



**SG 10433**  
Draw rod 125 cm



**SG 10434**  
Draw rod 150 cm

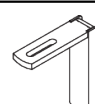

**SG 11206**  
Smart Fix with slot 60 mm

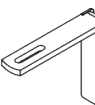

**SG 11207**  
Smart Fix with slot 80 mm



**SG 11208**  
Smart Fix with slot 100 mm



**SG 11216**  
Square Smart Fix with slot 60 mm



**SG 11217**  
Square Smart Fix with slot 80 mm



**SG 11218**  
Square Smart Fix with slot 100 mm



