

SG 4905

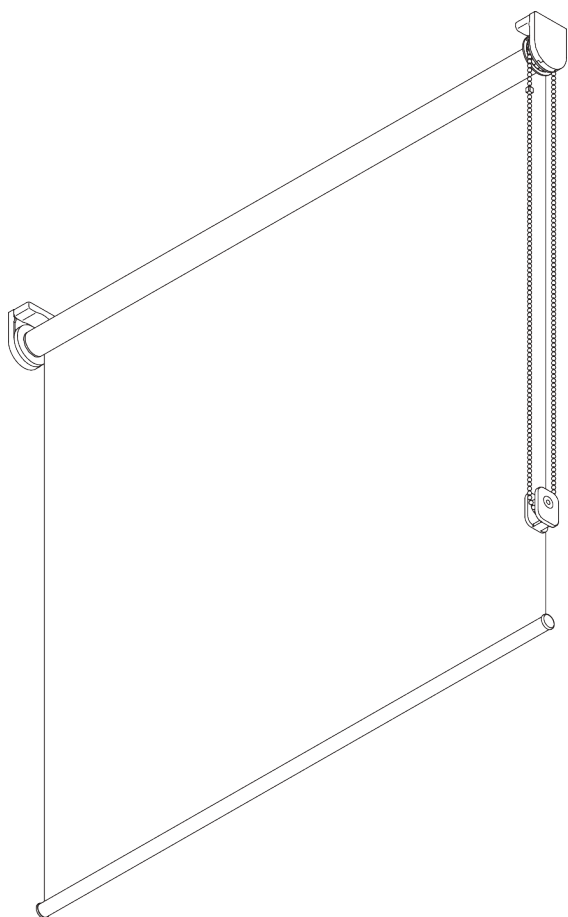
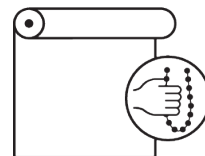

PRODUCT INFORMATION

- **Operation:** chain
- **Range:** S
- **Fitting:** ceiling, wall, recess
- **Colours:** 20 colours plus silver
- **Fabrics:** refer to Silent Gliss fabric collection

Features:

- Stainless steel bead chain
- Click-in brackets

SYSTEM SPECIFICATIONS

A. SYSTEM DIMENSIONS



1.6 m

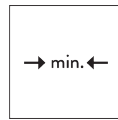

25 cm

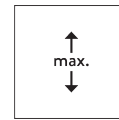

3 m



4.8 m²



1.3 kg

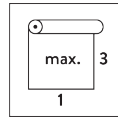

Recommended width /
height ratio
max. 1:3

Maximum system drop

Wall fitting (system drop on window side)

Fabric thickness	mm	0.15	0.20	0.25	0.30	0.35	0.40	0.45	0.50	0.55
Max. system drop	cm	300	300	300	300	290	260	240	210	190

Ceiling fitting / wall fitting (system drop on room side)

Fabric thickness	mm	0.15	0.20	0.25	0.30	0.35	0.40	0.45	0.50	0.55
Max. system drop	cm	300	300	300	300	300	300	290	260	240

B. PROFILE

Profile information

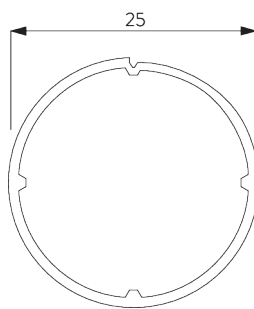

SG 10533

Tube ø 25 mm

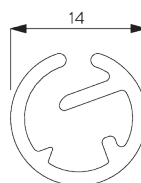

SG 10687

Bottom bar

C. HOW TO MEASURE

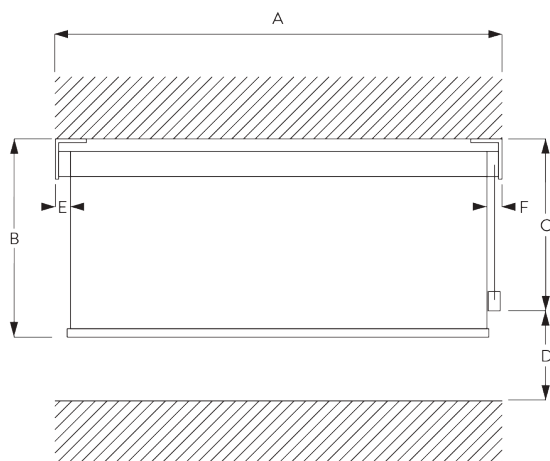

- A: System width
- B: System height
- C: Chain height
- D: Safety Retainer SG 10731 min. 150 cm above floor
- E: Light gap: 16 mm
- F: Light gap operation side: 21 mm

D. SPECIFICATION TEXT

EN

Silent Gliss SG 4905 Chain Operated Roller Blind System. Roller blind system for blind applications up to 1.6 m wide. Supplied made to measure and complete comprising anodised aluminium barrel SG 10533. Fixed to wall / ceiling/inside recess with brackets SG 10679 / SG 10680 and bracket covers SG 10683 / SG 10684. Assembled with powder coated aluminium bottom weight bar SG 10687. All parts are supplied colour matched to 27 Colorama colours, or silver. Compliant to Child Safety legislation EN 13120. Fabric to be chosen from the Silent Gliss fabric range Colorama 1 or Colorama 2.

SV

Silent Gliss SG 4905 kedjemanövrerat rullgardinsystem. Rullgardinsystem för installationer upp till 1.6 m bredd. Levereras komplett i specificerat mått innefattande anodiserat rör SG 10533. Vagg/tak och nischmontering med fästen SG 10679 / SG 10680 samt täckplattor SG 10683 / SG 10684. Monterad tyngdprofil i aluminium SG 10687. Alla delar levereras färgmatchade till 27 Colorama färger, alternativt silver. Uppfyller barnsäkerhetsnormen EN 13120. Textil från Silent Gliss textilprogram Colorama 1 eller Colorama 2.

NO

Silent Gliss SG 4905 Kjedebetjent rullegardinsystem. Rullegardinsystem for maks. bredde på 1,6 meter. Leveres komplett på spesialmål med anodisert rør integrert, SG 10533. Tak-,vegg- og nischmontering med feste SG 10679 / SG10680 og deksel SG10683 / SG10684. Monteret med tyngdeprofil i aluminium SG 10687. Alle deler leveres i matchene farger, tilpasset 27 Colorama-farger, alternativt sølv. Oppfyller barnesikkerhetsnormen EN 13120. Tekstil fra Silent Gliss kolleksjon Colorama 1 eller Colorama 2.

DA

Silent Gliss SG 4905 gardinskinnesystem med kædestyring. Rullegardinsystemer til installationer med op til 1,6 m i bredden. Leveres i ønsket længde og samlet. Består af anodiseret aluminiumrør SG 10533. Fastgøres i væggen / loftet / indfældes med beslagene SG 10679 / SG 10680 og beslagafdækningerne SG 10683 / SG 10684. Monteret med pulverlakeret tyngdeprofil af aluminium SG 10687. Alle dele leveres i matchende farver efter 27 Colorama-farver eller sølv. Overholder lovgivning om børnesikkerhed efter EN 13120. Stoffet vælges fra Silent Gliss stofprogrammet, Colorama 1 eller Colorama 2.

FITTING

A. FITTING INFORMATION

For detailed fitting information, visit the Silent Gliss website, login section.

Fixing points



B. CEILING FITTING

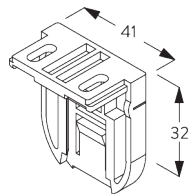
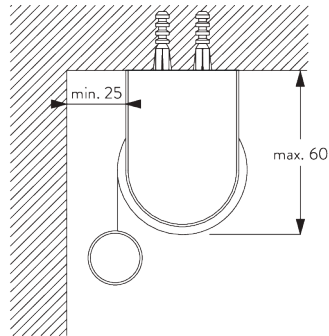

SG 10679
Bracket

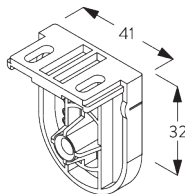

SG 10680
Bracket

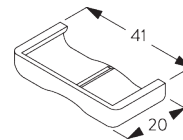

SG 10683
Bracket cover

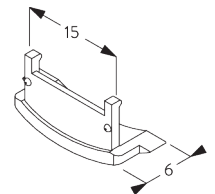

SG 10684
Cover

C. WALL FITTING

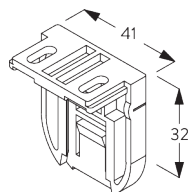
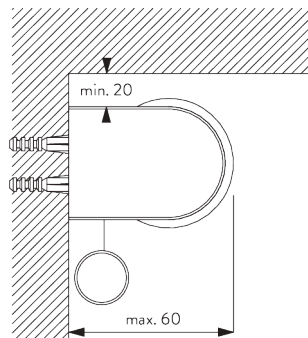

SG 10679
Bracket

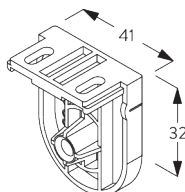

SG 10680
Bracket

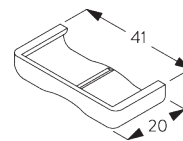

SG 10683
Bracket cover

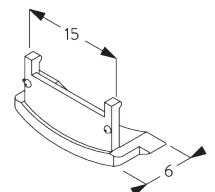

SG 10684
Cover

D. RECESS FITTING

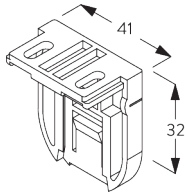
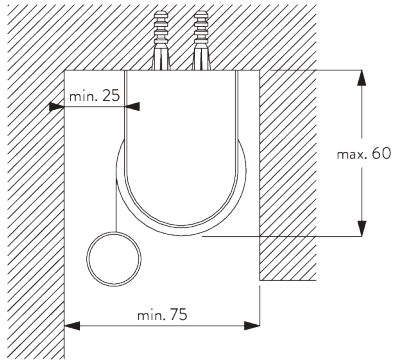

SG 10679

Bracket

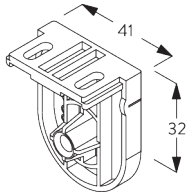

SG 10680

Bracket

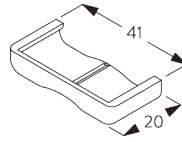

SG 10683

Bracket cover

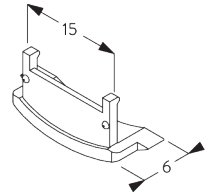

SG 10684

Cover

E. FITTING WITH SIDE GUIDE OPTION

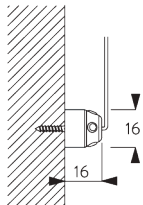
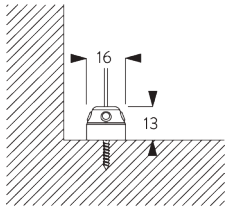

Single system

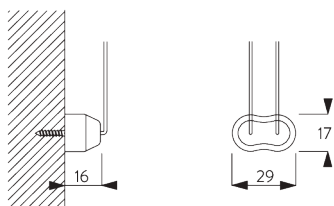
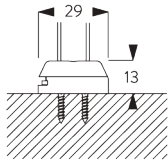

Double system (side-by-side installation)

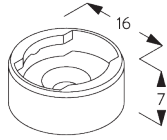

SG 8235
Side guide wire base short

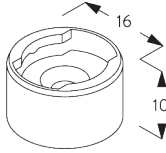

SG 8236
Side guide wire base long

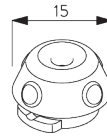

SG 8237
Side guide wire holder

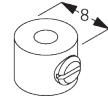

SG 8249
Side guide device

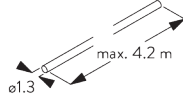

SG 10643
Side guide wire \varnothing 1.3 mm x 4.2 m

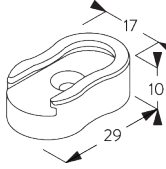

SG 10669
Side guide double base long

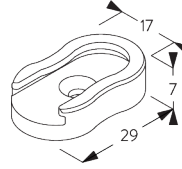

SG 10673
Side guide double base short

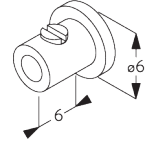

SG 10676
Device

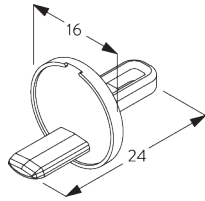

SG 10686
Side guide end cover

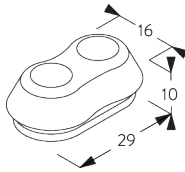

SG 10701
Side guide double wire holder

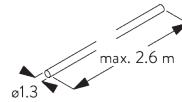

SG 10706
Side guide wire \varnothing 1.3 mm x 2.6 m

SYSTEM OPTIONS

A. FABRIC ROLL-OFF

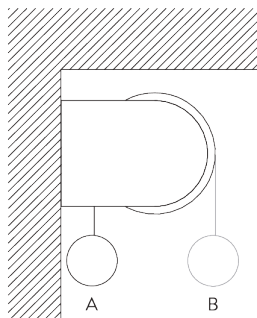
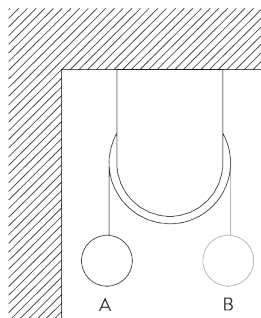

A: Fabric roll-off window side (standard)
B: Fabric roll-off room side (option)

B. SIDE GUIDES

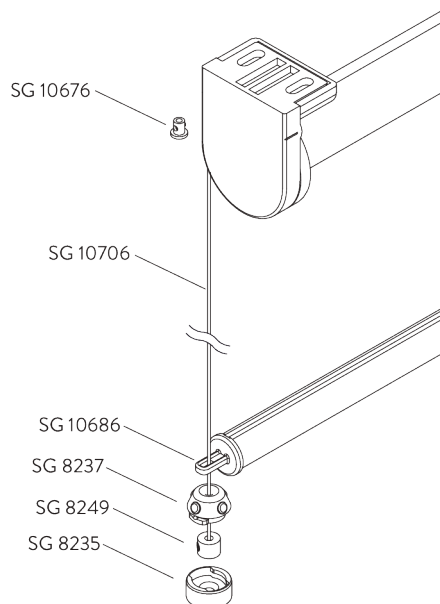

Additional parts:

- 2x SG 8235 Side guide wire base short
- 2x SG 8237 Side guide wire holder
- 2x SG 8249 Side guide device
- 2x SG 10676 Device
- 2x SG 10686 Side guide end cover
- 2x SG 10706 Side guide wire \varnothing 1.3 mm x 2.6 m

Optional parts:

- 2x SG 8236 Side guide wire base long
- 2x SG 10643 Side guide wire \varnothing 1.3 mm x 4.2 m
- 1x SG 10669 Side guide double base long
- 1x SG 10673 Side guide double base short
- 1x SG 10701 Side guide double wire holder

Note:

- Light gaps increase when side-guide option is used
- Up to 15° from vertical

C. CHILD SAFETY DEVICE

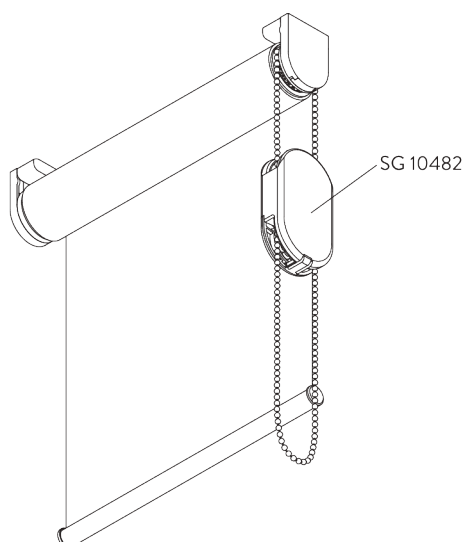

The child safety device SG 10482 releases the chain should the pulling force exceed 6 kg.

Note:

System to be installed so chain loop of child safety device ends at least 60 cm above floor.

PARTS

A. STANDARD PARTS

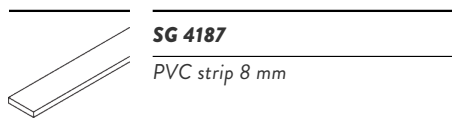

SG 4187
PVC strip 8 mm

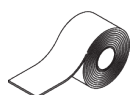

SG 4226
Double tape 30 mm



SG 10530
Bead chain metal ø 4 mm

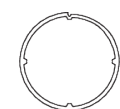

SG 10533
Tube ø 25 mm

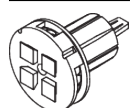

SG 10670
Chain drive, up to 1.3 kg fabric weight

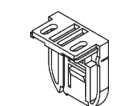

SG 10679
Bracket

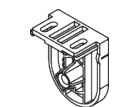

SG 10680
Bracket

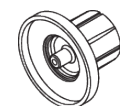

SG 10681
Tube adapter

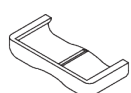

SG 10683
Bracket cover

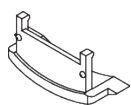

SG 10684
Cover



SG 10685
End cover



SG 10687
Bottom bar



SG 10709
Chain stop for ø 4 mm chain



SG 10731
Child safety retainer set

B. OPTIONAL PARTS



SG 8235
Side guide wire base short



SG 8236
Side guide wire base long



SG 8237
Side guide wire holder

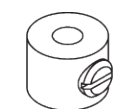

SG 8249
Side guide device

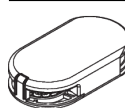

SG 10482
Child safety device set metal chain ø 4.0 mm

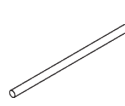

SG 10643
Side guide wire ø 1.3 mm x 4.2 m



SG 10669
Side guide double base long



SG 10673
Side guide double base short



SG 10676
Device



SG 10686
Side guide end cover



SG 10701
Side guide double wire holder

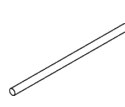

SG 10706
Side guide wire ø 1.3 mm x 2.6 m



SG 10710
Chain drive, up to 0.5 kg fabric weight